

OLSEN BATTEN

SUITABLE FOR CEILING OR WALL MOUNTING AND SUSPENDING

SAFETY INFORMATION:

To ensure correct function and safety, please read and follow all instructions carefully before using the product:

- Turn off power before installation or before doing any maintenance work.
- Do not install any luminaire near a heat source.
- For Indoor use only. Do not install this luminaires in damp or wet locations.
- Do not exceed the nominal supply voltage or amperage ratings.
- Take care not to pull any electrical wires during unpacking as this may damage the connection.
- Lay out all the components on a smooth surface and make sure there are no components missing before assembling.
- To avoid injury or damage to the fitting, please ensure that power leads and screws are secure before connecting the power.
- All Wiring and installation of the light fitting must adhere to AS/NZS 3000 Wiring Rules.

THIS IS A CLASS 1 PRODUCT AND MUST BE EARTHED

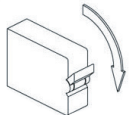
- 

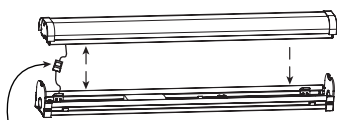
1
Isolate mains power
- 

2
(A) Remove diffuser by depressing the 4 clips to release
(B) Unplug the Power Connection
- 

3
Feed mains cable through grommet in base tray
- 

4
Mark fixing holes
- 

5
Drill holes
- 

6
Insert rawl plugs
- 

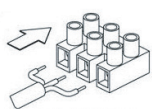
7
Fix in position minimum 2 spaces
- 

8
Terminate mains cable Live, Earth, Neutral and securely clamp the supply cable
- 

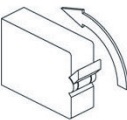
9
Connect the power connection & ensure all the 4 clips engage
- 

10
Restore mains power and test to ensure correct operation

Vynco Industries (NZ) Limited

Christchurch Office

388 Tuam Street, Phillipstown, Christchurch, 8011
PO Box 9022, Tower Junction, Christchurch 8149
New Zealand
P +64 3 379 9283 F +64 3 379 6838
E sales@vynco.co.nz
www.vynco.co.nz

Auckland Office

9 Levene Pl, Mount Wellington
PO Box 12 249, Penrose, Auckland 1061
New Zealand
P +64 9 525 6051 F +64 9 525 5799
E sales@vynco.co.nz
www.vynco.co.nz

OLSEN BATTEN

SUITABLE FOR CEILING OR WALL MOUNTING AND SUSPENDING

INSTALLATION INSTRUCTIONS:

- Switch off before installation.
- Switch on only after complete installation and examination of the circuit.
- Professional electrician for installation and maintenance only.

Turn Off power supply before starting any installation. Read instructions & check you have all the tools & accessories to complete the installation correctly.

Step 1

Press the snap-on button and remove the cover.



Step 3

Connect the DC plug. Press the snap-on button and fix the cover to the base.

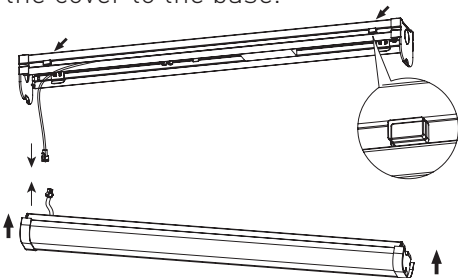

Step 4

Installation complete

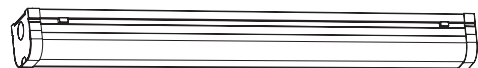

Step 2

Knock plastic anchor into ceiling.
Connect the cable to terminal block. Fix the base to the ceiling.

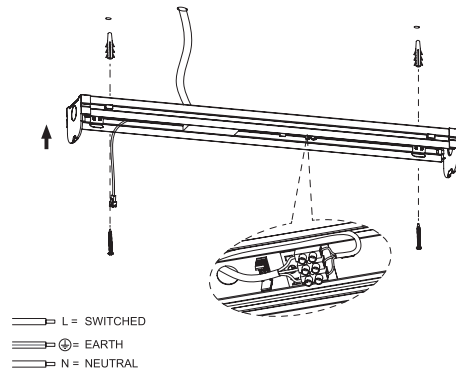

WARRANTY:

This product is covered by the standard 3 year Vynco Warranty - proof of purchase is required. Please contact Vynco for details of returns procedure.

NOTE: This product contains NO user serviceable parts.

Vynco Industries (NZ) Limited

Christchurch Office

388 Tuam Street, Phillipstown, Christchurch, 8011
PO Box 9022, Tower Junction, Christchurch 8149
New Zealand
P +64 3 379 9283 F +64 3 379 6838
E sales@vynco.co.nz
www.vynco.co.nz

Auckland Office

9 Levene Pl, Mount Wellington
PO Box 12 249, Penrose, Auckland 1061
New Zealand
P +64 9 525 6051 F +64 9 525 5799
E sales@vynco.co.nz
www.vynco.co.nz