

VYNCO LIGHTING



STALLONE

LED FLOODLIGHT



PRODUCT SPECIFICATION

CODE	TYPICAL POWER (W)	LUMENS OUTPUT (lm)	COLOUR TEMPERATURE (K)	EFFICACY (lm/W)	COLOUR
F105	10	1000	5000	100	Black
F305	30	3000	5000	100	Black
F505	50	5000	5000	100	Black
F1005	100	11000	5000	110	Black
F1505	150	16500	5000	110	Black
F2005	200	22000	5000	110	Black

COMMON SPECIFICATION

Power Factor	>0.95	Materials/Construction	Die cast Aluminium
Input Voltage	100~240V a.c.	LED Chip	Osram
Beam Angle	120°	Driver Make	Meanwell
Glare Rating	-	Operating Temperature	-40°C ~ +50°C
Colour Rendering	70	Dimming	No
IP Rating	IP65	Projected Life (hrs)	50,000
IK Rating	IK08	Class	I

CERTIFICATES & APPROVALS



EN 60598-2-1:1989

EN 60529:2013

IEC 61347-2-13:2006

DIMENSIONS

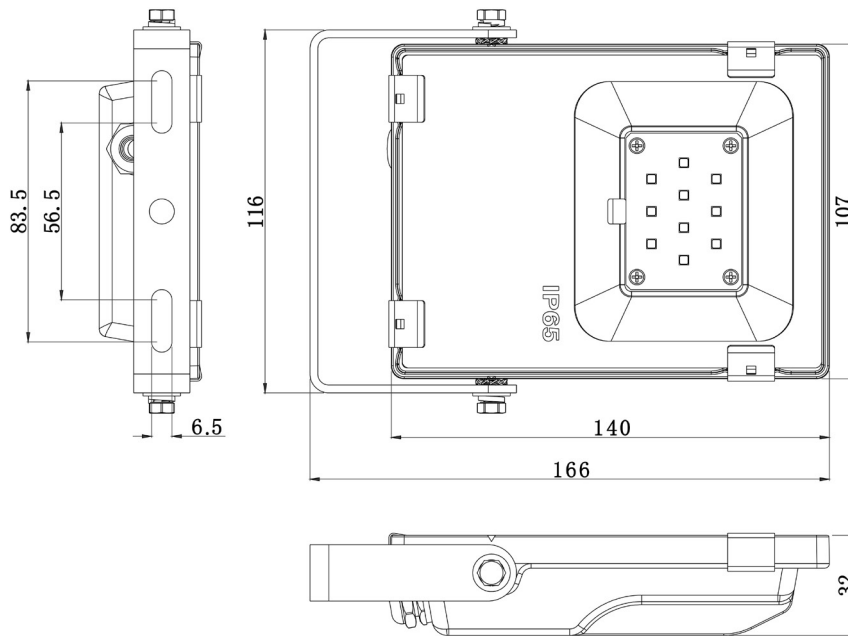

F105 Dimensions shown

CODE	LENGTH (mm)	WIDTH (mm)	DEPTH (mm)	WEIGHT (kg)
F105	166	107	32	0.6
F305	226.5	167	40	1.4
F505	310.5	220	47.5	2.1
F1005	402.5	295	53.5	5.1
F1505	430.5	330	53.5	6.2
F2005	470.5	360	53.5	7.1

1 meter long lead

PHOTOMETRICS

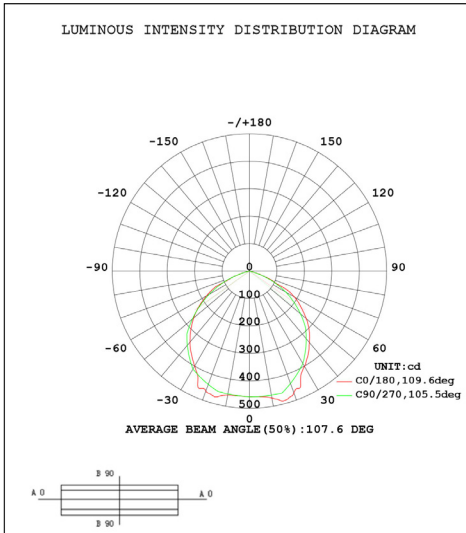

F105

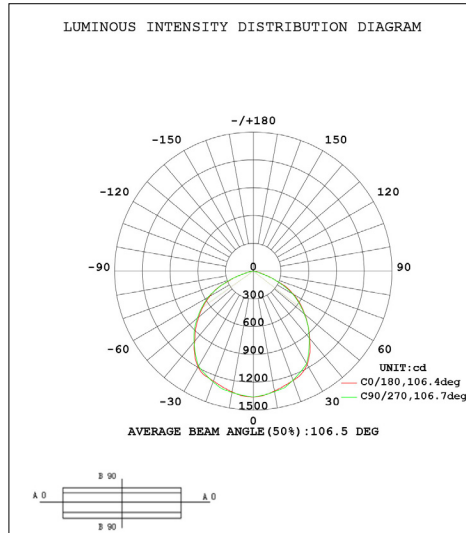

F305

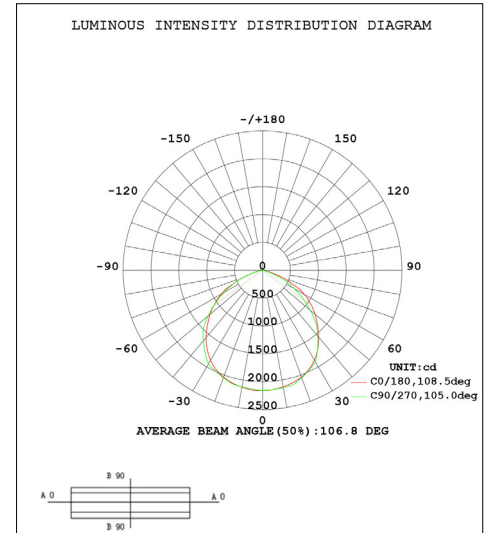

F505

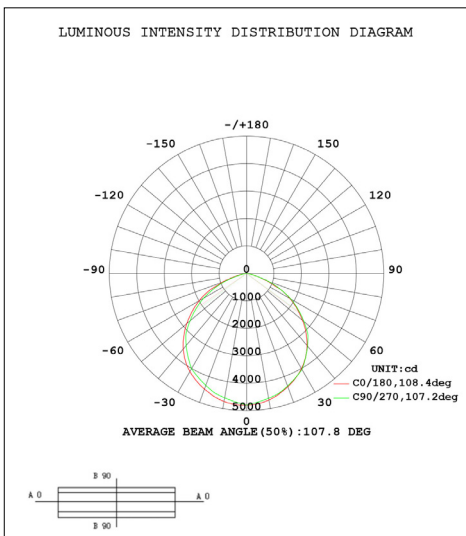

F1005

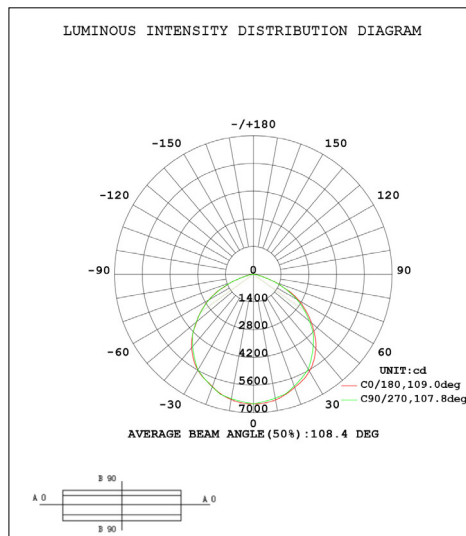

F1505

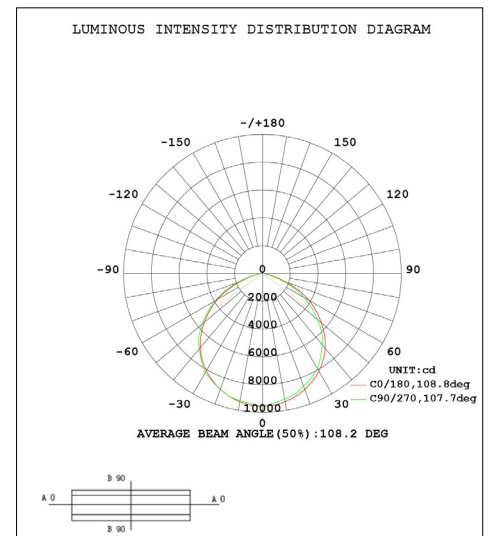

F2005