

VMC351 - 51 WAY THREE PHASE SERIES COMBINED METER BOARDS

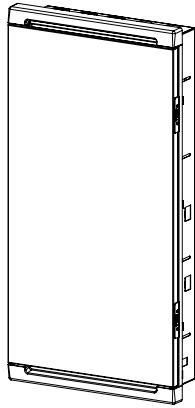

WARRANTY

This product is covered by a 1 Year Vynco Warranty - proof of purchase is required. Please contact Vynco for details of returns procedure.

NOTE: This product contains NO user serviceable parts.

SAFETY

This product complies in full with AS/NZS 61439.3.

This product should be installed by a suitably qualified person in accordance with Australian and New Zealand wiring rules.

INSTALLATION PROCEDURE

This product is designed to be installed inside a wall cavity with a minimum stud size of 90mm and a minimum plaster board/wall covering of 10mm.

The metal wall enclosure must be earthed. Fold out tags (x6) on the side walls of the enclosure can be folded out to set the correct height onto the studs.

Door hinge pins are easily removable and the door can be reversed so that it swings either left or right. This product is designed to be used with New Zealand and Australia's MEN system.

DO NOT install a link between the neutral bars and earth bar on circuits dedicated to RCDs. Please ensure circuits and protective devices are adequately identified during installation.

SPECIFICATIONS

Rated Operational Voltage	415V AC maximum, 50Hz
Maximum Current	100A
Rated Insulation Voltage	1000V
Short Circuit Withstand	10kA

DIMENSIONS

Cover Assembly	900 x 402 x 77mm
Base Box Dimensions	853 x 355 x 150mm
Overall Assembled Dimensions	900 x 402 x 171mm
Total Internal Meter Mounting Space	310 x 320 x 139mm
Maximum Meter Depth	130mm

VYNCO INDUSTRIES (NZ) LIMITED

CHRISTCHURCH

388 Tuam Street, Phillipstown, Christchurch, 8011
 PO Box 9022, Tower Junction, Christchurch 8149
 New Zealand
 P +64 3 379 9283
 E sales@vynco.co.nz

VYNCO.CO.NZ

AUCKLAND

9 Levene Place, Mount Wellington
 PO Box 12 249, Penrose, Auckland 1061
 New Zealand
 P +64 9 525 6051

VMC351 - 51 WAY THREE PHASE SERIES COMBINED METER BOARDS

EARTH AND NEUTRAL BUSBAR LAYOUT

	Material	Number of Bars	Double Screw Tunnels	Single Screw Tunnels
Earth Bar	Brass with steel screws	1	3	40
Neutral Bar	Brass with steel screws	1	4	22
RCD Neutral Bar	Brass with steel screws	8	1	3

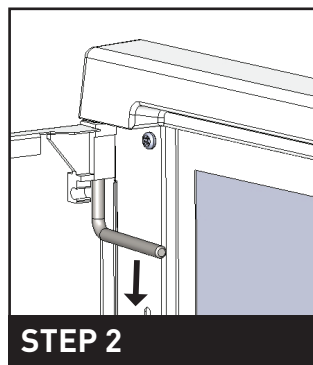
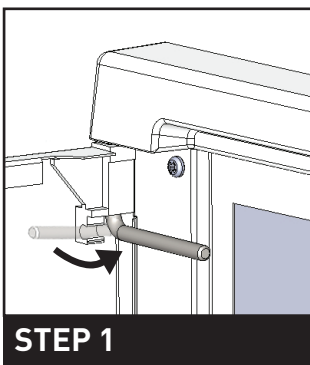

REMOVING DOOR

STEP 1

Rotate top pin 90°.

STEP 2

Slide pin down to release door. There is no need to remove pin completely.

STEP 3

Lift and remove door.

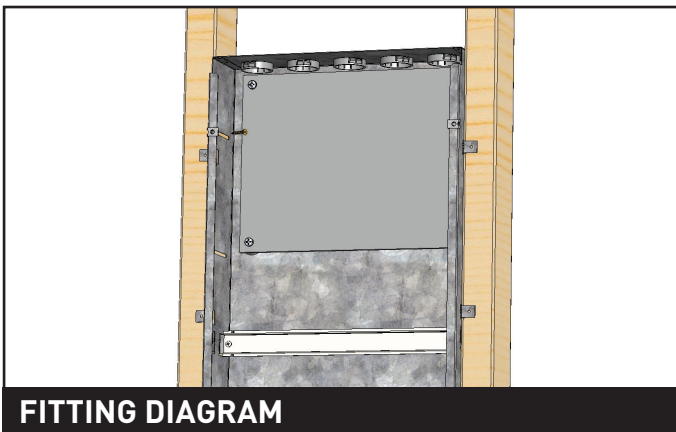
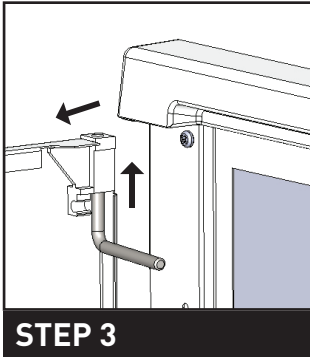

FITTING DIAGRAM

To fit into wall cavity, fold out tabs to set height of enclosure onto studs.